

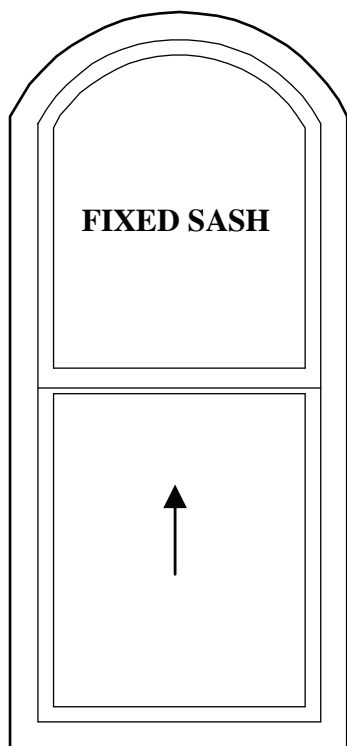

**SWEPT HEAD ARCH**

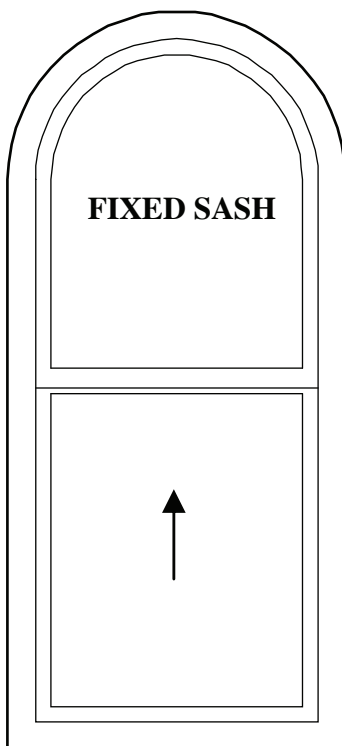

**TRUE ARCH**



**GOTHIC ARCH**

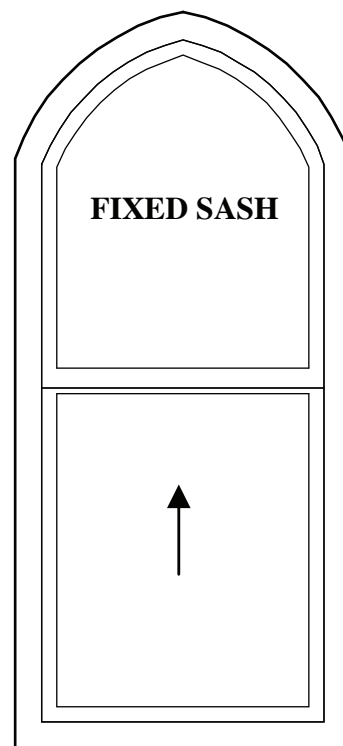

# Contents

Introduction.....	3
SWEPT HEAD ARCH .....	3
Swept Head Arch Information .....	5
TRUE ARCH .....	6
True Arch Information .....	7
GOTHIC ARCH .....	8
Gothic Arch Information .....	8

# Introduction

An arch is something that consists of a curved top spanning the upper edge of an open space. A curve with the ends down and the middle up, giving a bow like appearance.

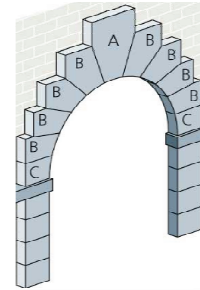

When ordering a normal rectangular windows, the width and height of the outer frame are the required dimensions. When ordering arched windows, customers spend a lot of time and expenditure, marking and cutting out templates to the required shape. The majority of the time this procedure is not necessary. As with a square/rectangular window, only dimensions are required. The width and height on a square/rectangular window being the same as the width and overall height on an arched window. For an arched window a third dimension is required. The shoulder height or what some call the spring-line. The shoulder height or spring-line is the point at which the curve on the arch starts and finishing at the point, middle of the width and overall height.

Arched windows must be symmetrical, the left hand side and the right hand side are a mirror image of each other.

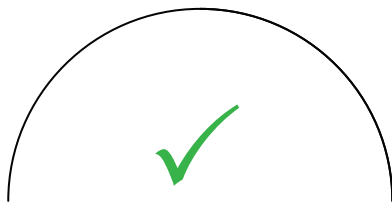

Symmetrical  
Left & Ride hand sides the same

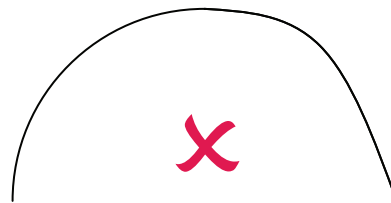

asymmetrical  
Left & Ride hand sides different

It is important to remember that all types of arches have **Fixed Top Sashes**.

Only under specific circumstances can a **Swept Head Arch** have a sliding topsash. This is only possible when the distance between the shoulder height and the overall height are of a shallow distance.

It is important to remember that the customer does not assume that the topsash will be sliding. This must be agreed with Victorian Sliders and in writing.

# Swept Head Arch

Window Number	
Transom Drop	

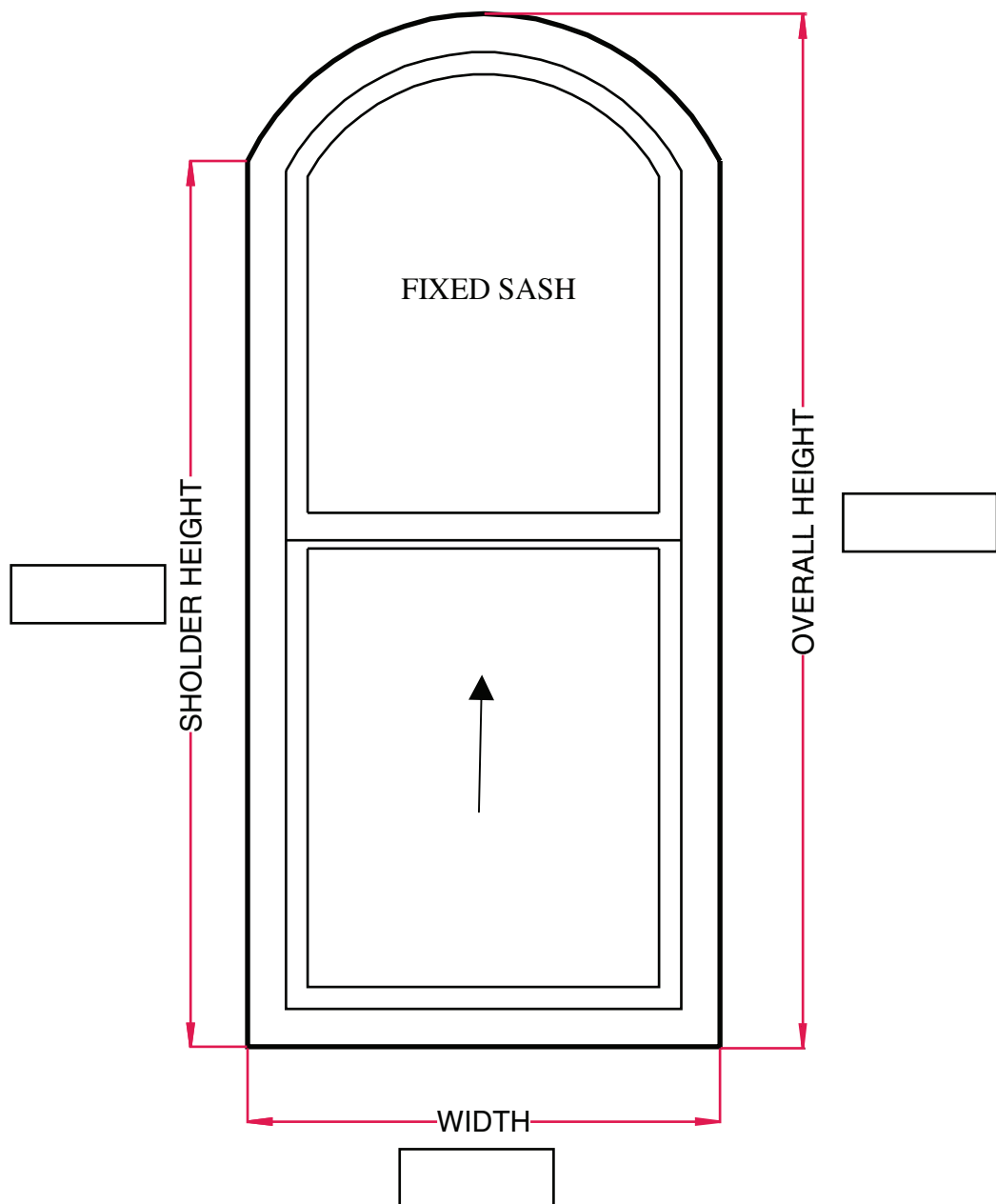

# Swept Head Arch

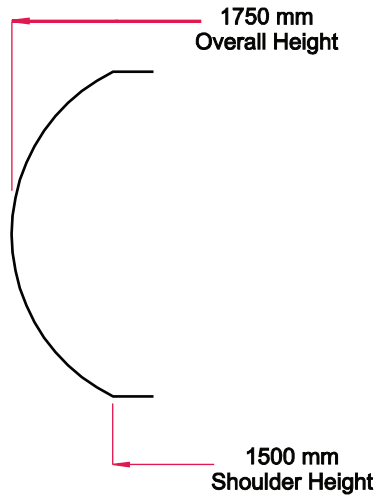

Note: For a Swept Head Overall Height + Shoulder Height is required.

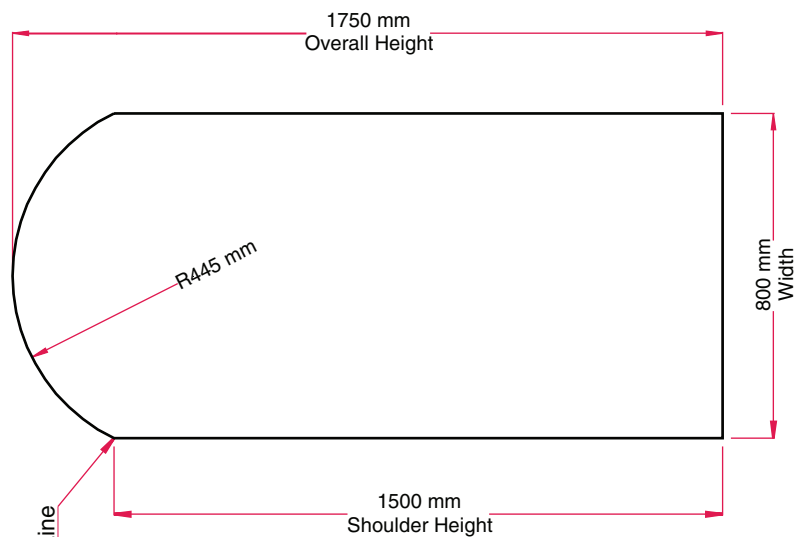

SWEPT HEAD ARCH

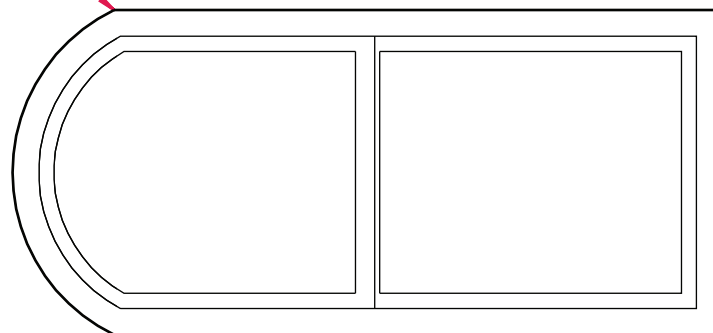

# True Arch

Window Number	
Transom Drop	

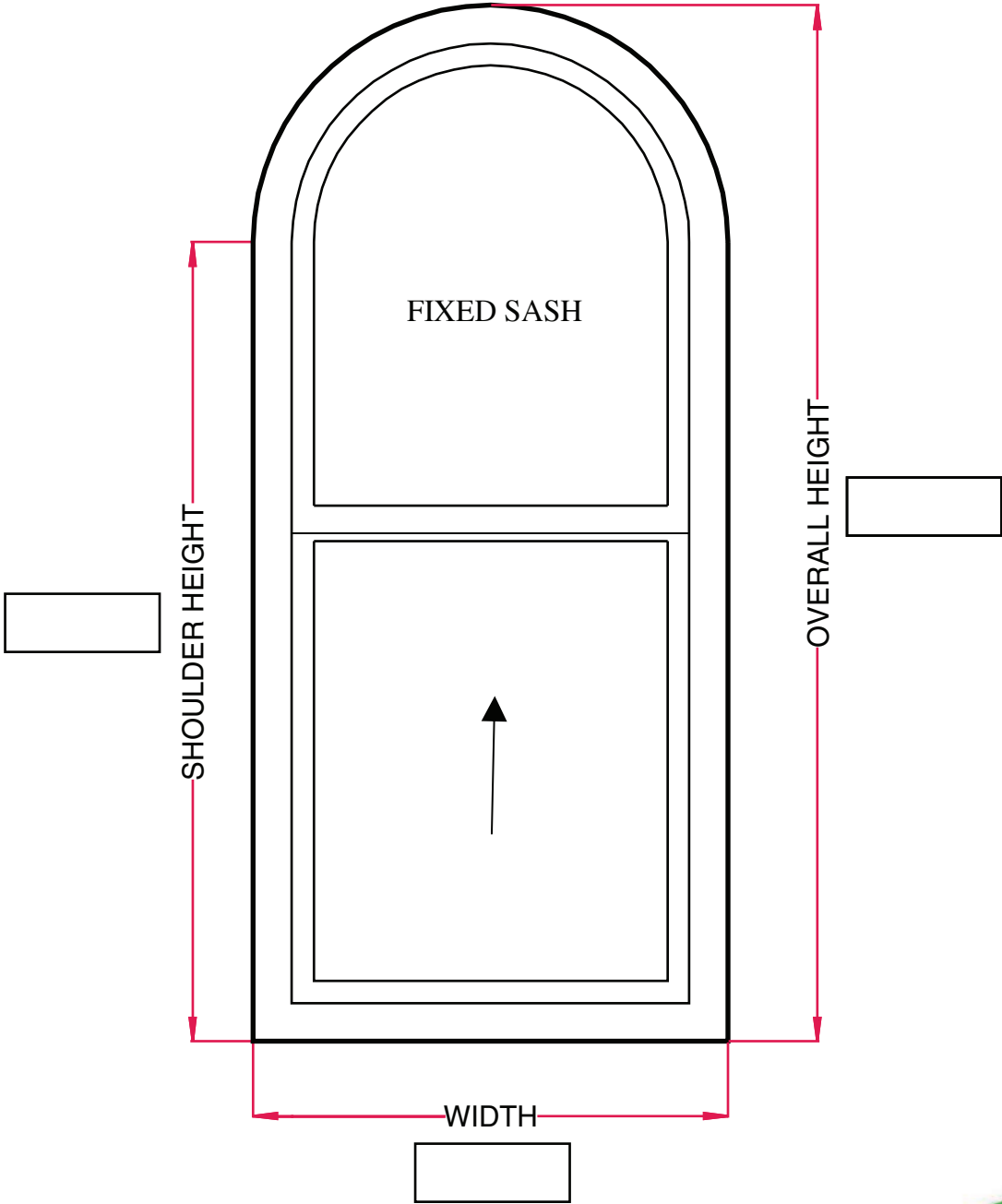

# True Arch

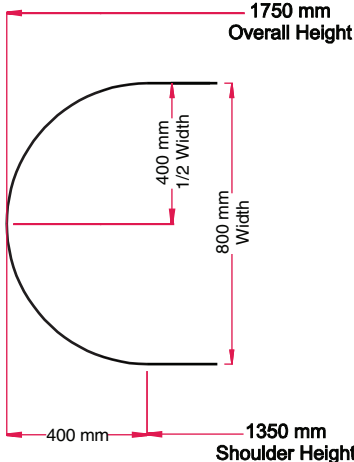

Note: For a True Arch  
 $1/2 \text{ Width} = \text{Overall Height} - \text{Shoulder Height}$   
 $400 \text{ mm} = (1750 \text{ mm} - 1350 \text{ mm})$   
 $400 \text{ mm} = 400 \text{ mm}$

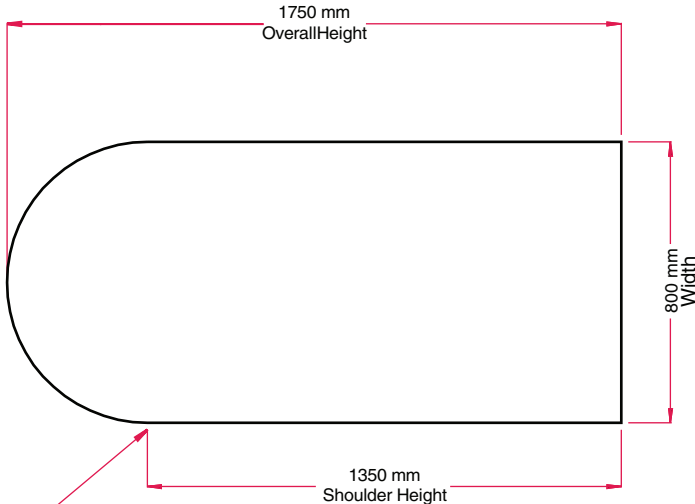

Spring Line

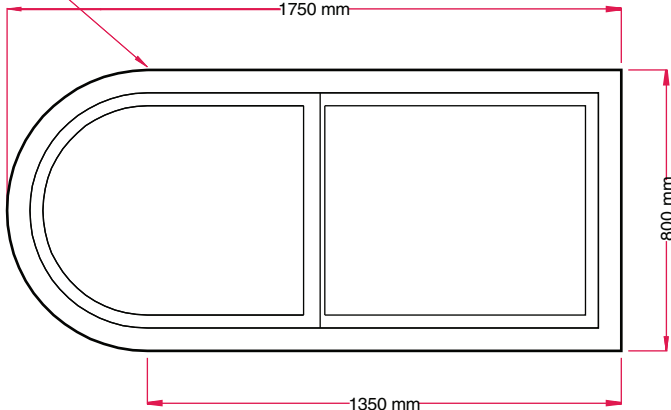

# Gothic Arch

Window Number	
Transom Drop	

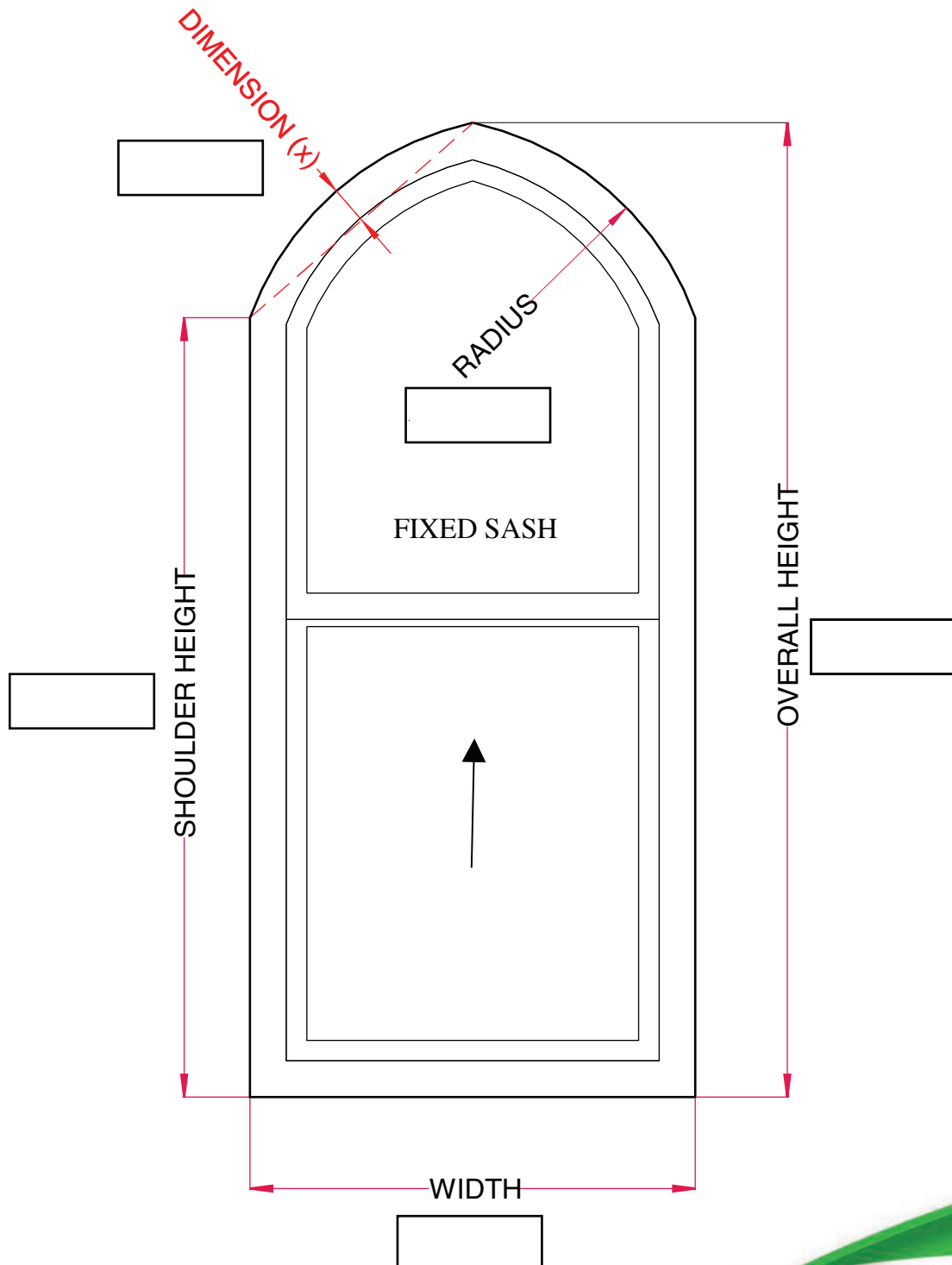



# Gothic Arch

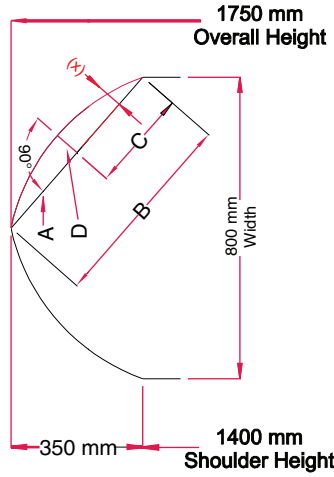

Note: If Radius is not known Dimension (x) is required

A: Draw Line from shoulder to peak

B: Measure Line

C: Half Lines Length

D: Draw a line 90,00° from Mid - Point to Arc & measure line (x)

Example:

B: 532 mm

C: 266 mm

D: 69 mm = (x)

GOTHIC ARCH

